

• Deflection of Part. S0637 - S0638

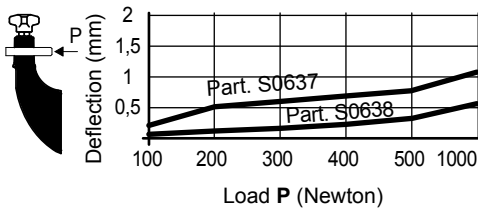

• Technical data Part. S0637 - S0638

- Sliding load resistance: - Breaking load:

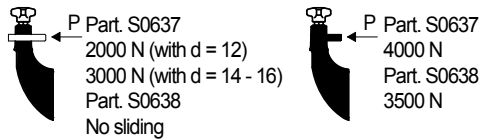

Tests performed at tightening torque: 4 Kgm

• Part. S0637 - S0638 permit application of 1 or more spacer Part. S0725.

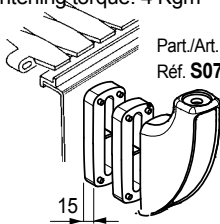

• Part. S0637 permit application of spacer Part. S0227.

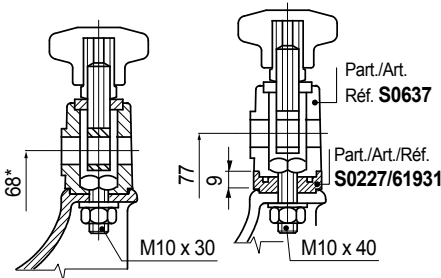

* = To increase the height (by 9 mm) use 1 spacer Part. S0227 code 61931. To use the spacer it is necessary a longer screw.

• Part. S0638 permit application of spacer Part. S0227.

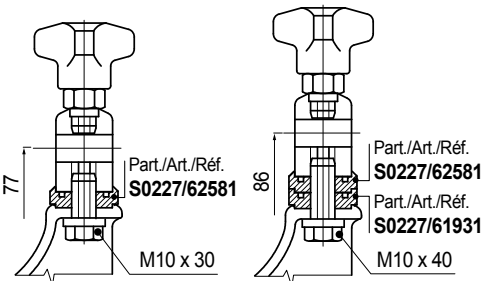

To use the spacer Part. S0227 it is necessary a longer screw.

• Part. S0226 - S0336. Part. S0637 and S0638 permit application of drip tray support.

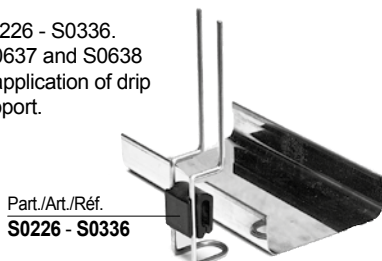

■ Adjustable bracket

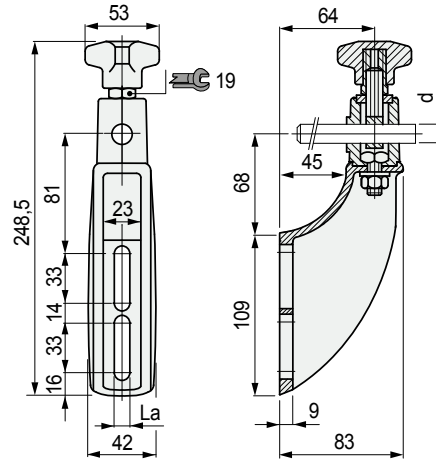

Pin dia. d mm	Code		Weight kg
	La = 9 mm	La = 10,5 mm	
12	605423	648372	0,40
14	605433	648382	
16	605443	648392	

- Material: bracket, swivel head and knob in reinforced polyamide (black), hexagonal insert (for 19 mm wrench) in nickel plated brass, eyebolt and tightening nuts/bolt in austenitic stainless steel.
- Operation: by untightening the bolt, the position of the top can be adjusted. By untightening the knob, the position of the pin can be adjusted.
- Max recommended tightening torque: 4 Kgm.
- Packaging: 50 pieces.

■ Adjustable bracket

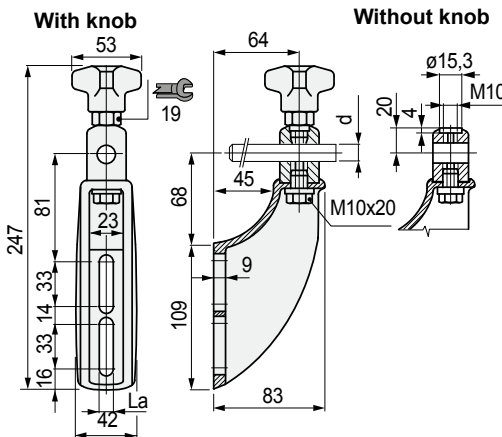

Pin dia. d mm	Swivel head material	Code		Weight kg
		La = 9 mm	La = 10,5 mm	
With knob				
14÷16	Austenitic stainless steel	610953	648402	0,50
	Nickel plated brass	610963	648412	
Without knob				
14÷16	Austenitic stainless steel	610973	648422	0,50
	Nickel plated brass	610983	648432	

- The bracket can be used with dia. 14 and dia. 16 mm pins.
- Material: bracket and knob in reinforced Polyamide PA.FV (black), hexagonal insert (for 19 mm wrench) in nickel plated brass, tightening nuts/bolt in austenitic stainless steel.
- Operation: by untightening the bolt, the position of the top can be adjusted. By untightening the knob, the position of the pin can be adjusted.
- Max recommended tightening torque: 4 Kgm.
- Packaging: 25 pieces.

Part. S0637



Part. S0638



Stainless steel and brass swivel head

● Best Seller

● Standard

● On request: minimum quantity may apply. Consult our Customer Service for availability.

Item code for order = Part. + Code