

Part. **S0874**

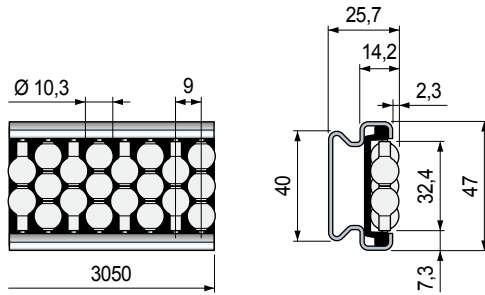

■ Pearl roller side guide



Pearl material	Code	Weight kg
Polyethylene PE (Aubergine)	649353	1,55
Polyethylene PE (white)	649363	

- Material: metal profile in Austenitic stainless steel, rollers module in acetal POM (black), roller pins in stainless steel.
- Standard packaging: strands 3,05 metres.
- Packaging: 2 strands.

The roller side guides can be supplied with separated components.

Metal profile

Pearls module

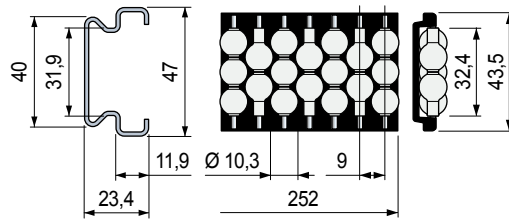

Length mm	Code	Materiale Perle™	Code
3050	649413	Polyethylene PE (Aubergine)	644653
		Polyethylene PE (white)	644633

- Material: Austenitic stainless steel.
- Weight: 1,21 Kg/m.
- Packaging: 1 strand.

Part. **S0794**



■ Side Clamp

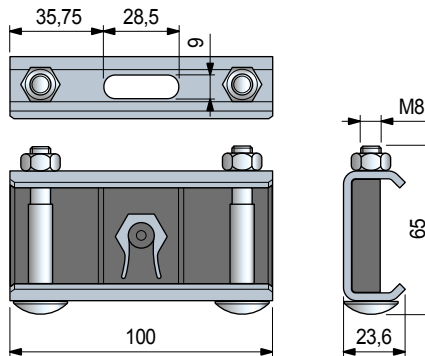

Metal Body	Code	Weight kg
Ferritic Stainless Steel	625363	0,28

- Plastic Insert Material: POM (Black).
- Hardware: Stainless Steel.
- Packaging: 12 pieces.

• Characteristics Part. S0874

- Self supporting structure.
- Metal Profile in Austenitic stainless steel.
- Quick and easy installation by standard bolts.
- Can be used straight running and sidexfing.

• Assembly Part. S0874

M10 hex head bolt

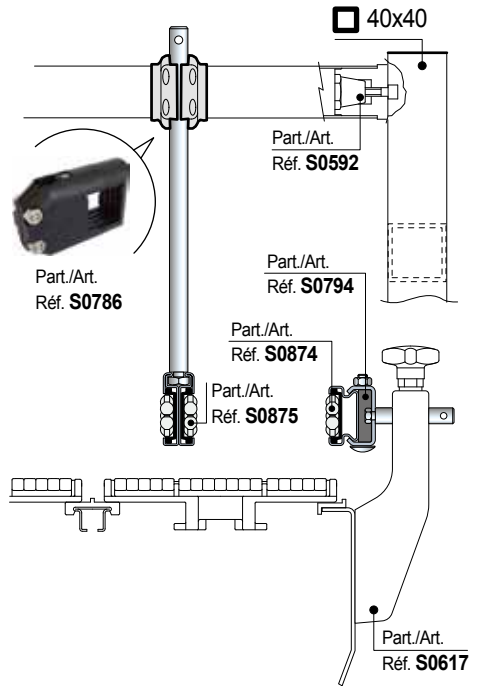
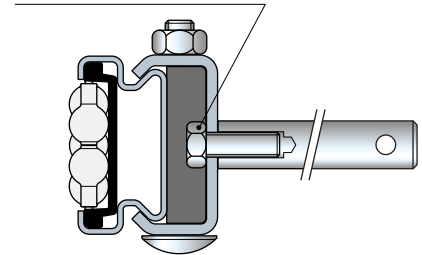

• Min. curvature radius Part. S0874

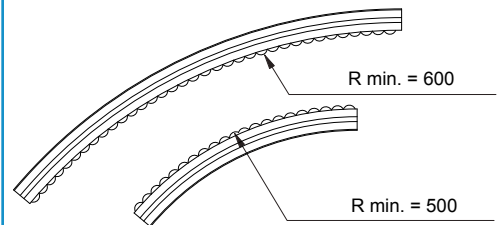

• Installation - side Usage

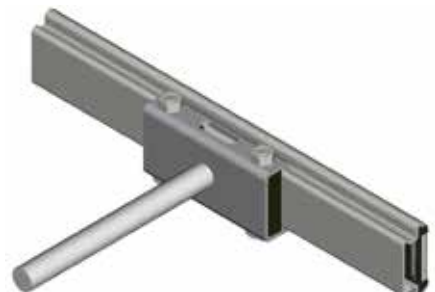

● Best Seller

● Standard

● On request: minimum quantity may apply. Consult our Customer Service for availability.

Item code for order = Part. + Code