

Part. **S0872**

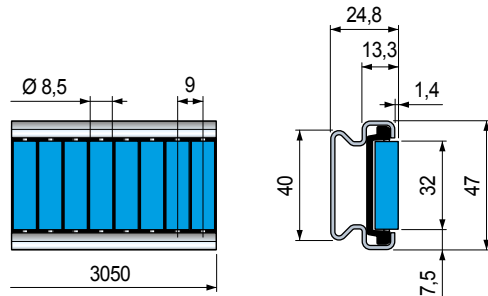

■ Roller side guides with cylinder rollers



Cylinder rollers material	Code	Weight kg
SEBS Rubber (Blue)	649333	1,60

- Material: metal profile in Austenitic stainless steel, rollers module in acetal POM (black), roller pins in stainless steel.
- Standard packaging: strands 3,05 metres.
- Packaging: 2 strands.

The roller side guides can be supplied with separated components.

Metal profile

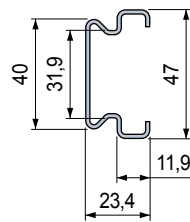

Length mm	Code
3050	649413

Cylinder roller module

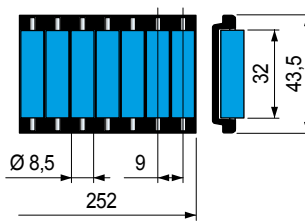

Cylinder rollers material	Code
SEBS Rubber (Blue)	646523

- Material: Austenitic stainless steel.
- Weight: 1,21 Kg/m.
- Packaging: 1 strand.

Part. **S0794**



■ Side Clamp

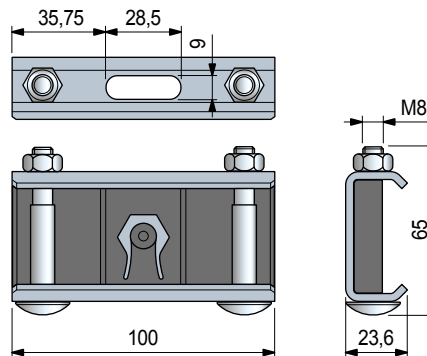

Metal Body	Code	Weight kg
Ferritic Stainless Steel	625363	0,28

- Plastic Insert Material: POM (Black).
- Hardware: Stainless Steel.
- Packaging: 12 pieces.

• Characteristics Part. S0872

- Self supporting structure.
- Metal Profile in Austenitic stainless steel.
- Quick and easy installation by standard bolts.
- Can be used straight running and sideflexing.

• Assembly Part. S0872

M10 hex head bolt

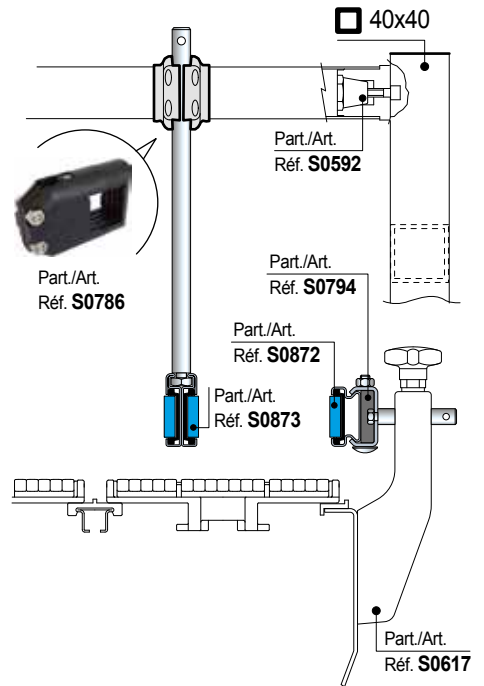
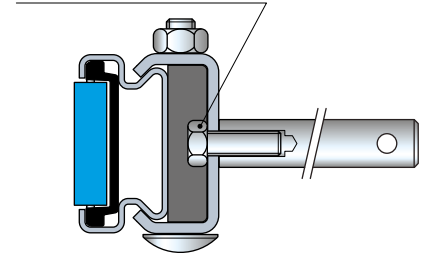

• Min. curvature radius Part. S0872

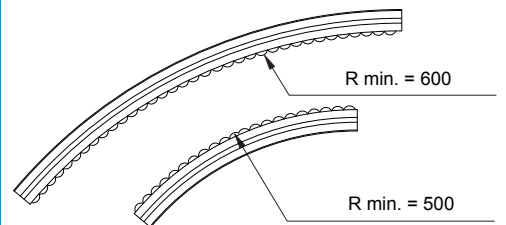

• Installation - side Usage

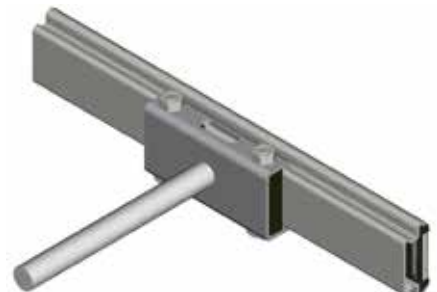

● Best Seller

● Standard

● On request: minimum quantity may apply. Consult our Customer Service for availability.

Item code for order = Part. + Code